



## URBAN FIREPITS

Beyond The Flame

Outdoor fireplaces, bringing friends  
and family together.



# FIREPITS, FIREBOWLS, WALL FIRES & FIRETABLES

Choose from stone, porcelain,  
engineered stone, handmade  
polished or industrial-finish  
concrete and bespoke metal.

Customise your look.

Full remote control.

The genius is in the detail.

PROUDLY MADE IN GREAT BRITAIN





# CONTENTS

5	Astra firebowls
7	Benno square firepits
9	Dakota linear firepits
11	Bespoke firepits
13	- continued
15	Firetables
17	Wall fires
19	More wall fires
21	Specialist fireplaces
23	Woodburning fires
25	Outdoor kitchens
26	Fuel bed options
27	Pebbles
28	Specifications
29	Contact us

It is acknowledged that all Urban products create the most realistic flames. Our Signature gas burners are state-of-the-art, developed from many years of evolution.

All these outdoor fireplaces can be supplied for use on natural gas (NG) from the house, propane gas (LPG) cylinders or even bioethanol liquid fuel. Your choice.

Our gas models come with full electronic handheld remote control or can be operated by a home automation system.

This brochure will offer a flavour of our abilities, but there are many, many more examples to be found on our website.



# ASTRA FIREBOWL

## Beyond the Flame

Astra firebowl is handmade from polished or industrial reinforced concrete, so strong that we can make it thinner than you might imagine, for maximum aesthetic effect.

Due to the nature of the process, no two firebowls will look exactly the same.

And there are choices, of course. Six colours, of gas type (mains gas or LPG cylinders), of operation - on bioethanol liquid fuel - and a choice of pebble colours, too.





Yes, Astra is the genuine ITV Love Island firebowl!



# BENNO FIREPIT

Beyond the Flame

Benno has a square fuel bed and the option of ceramic pebbles (shown with mixed colours here) and of course is made from our finest reinforced concrete in a choice of six colours.

Benno can now also be made from a range of 30 Photon porcelain colours.

Benno offers ignition by handheld remote control and also can be controlled by your home automation program.

There and of mains gas, LPG or bioethanol liquid fuel operation.







# DAKOTA FIREPITS

## Beyond the Flame

We named our range of linear firepits Dakota. In three widths, any one of them will enhance your deck - with enough surface space for your glass of wine or BBQ meal.

Not only do our innovative gas burners create the best flames, the Dakota range has handheld remote control and can even be controlled by a home automation program.

And more, there's a choice of six stunning colours and ceramic pebbles to suit your style.





# PHOTON FIREPITS

Beyond the Flame

Of course, whilst we offer standard sizes in concrete, we specialise in helping designers and home owners to create something unique in one of the many colours or shades of our unique Photon porcelain construction.

This bespoke firepit was commissioned for a Home Counties client and although it was as large as 1800 x 1200 it only weighed 75kg and was carried by just two technicians.









# BESPOKE FIREPITS

## Beyond the Flame

We often work with designers who have already developed a firepit style for your project.

Alternatively, we can create a design in stone or porcelain, polished concrete, painted metal or Corten steel. Or it may be that you just want a gas or bioethanol burner suitable for outdoors.

Send your drawings or visuals by email and we'll react with detailed site-specific technical information and a fair quotation.









# FIRETABLES

## Beyond the Flame

Our stunning firetables are made-to-measure. They are not more expensive, but you will have a choice of materials, colours and dimensions.

Your contractor may even be able to build some of the component parts, which may reduce your costs further.

On sight of your drawings or visuals we'll be pleased offer a competitive quotation to supply or install one of our fabulous firetable creations.







# WALL FIRES

## Beyond the Flame

Working with your preferred designer or contractor, we make outdoor fireplaces to your size and in your style.

Gas, woodburning or bioethanol, we use our innovative Signature gas burners to best advantage in a bespoke firebox.

There are examples on our website, just too numerous to publish here. Send your drawing or visual and be sure we will provide you with our best flame.









# MORE WALL FIRES

## Beyond the Flame

The choice of styles may surprise you. Our bespoke fireboxes can be made from black, weathercoated galvanised steel, brushed stainless steel, or our lifetime guaranteed marine-grade stainless steel.

Optionally, we can line the inside with black mirror glass or a wide range of decorative porcelain sheet, or even amazing 3D carved stone tablets using 5-axis machining.

As you can see from this amazing one-off, if you can imagine it, we can make it.









# SPECIALIST OUTDOOR FIREPLACES

Fireplaces for use in enclosed outdoor areas.

Sometimes your scheme or design may not be compatible with the regulations that we have to follow.

For example, if your outdoor space has a roof and more than two walls, it may not be possible to install an open-fronted outdoor gas fireplace in some jurisdictions.

However, using one of our innovative Specialist designs will afford the possibility to provide ambience and heat to such an extension, outdoor space or pergola system.

There are three designs, 750 wide, 1400 wide and the amazing 1600 Vertical - with a see-through option - and all with modern fuel-bed options (including the unique LED WOW factor fuel-bed).



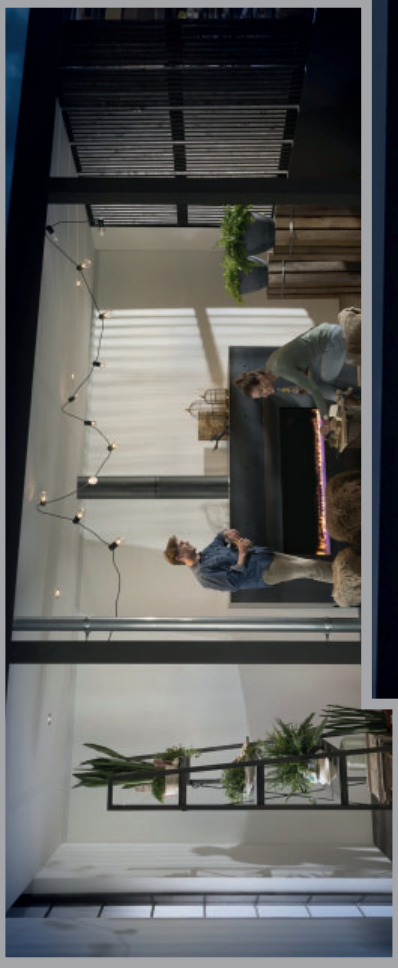
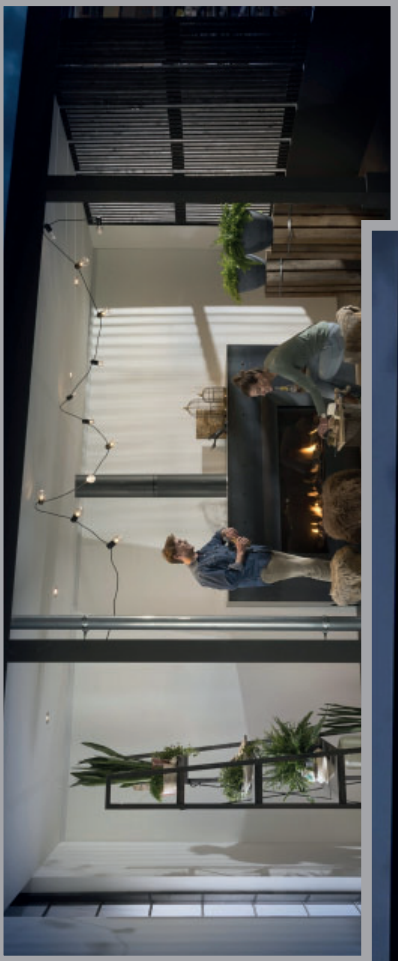
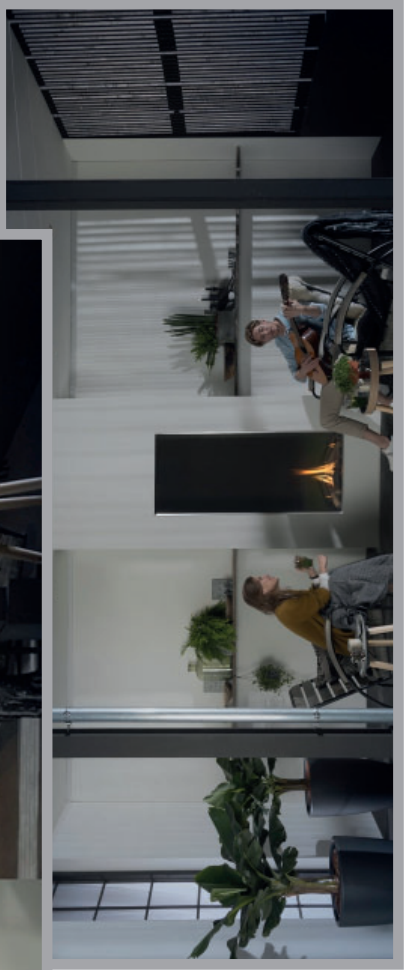



# WOODBURNING FIRES

## Beyond the Flame

We are proud to offer this new range.

Our woodburning cooking/fireplace range is also a barbecue! Contemporary, like the Mode shown here or a more traditional look - your choice.

Yes, you can cook great food on the height-adjustable grille and you can also use the built-in tray to make embers or charcoal in the *braai* style.

This range is the only one of our outside fireplaces which needs a chimney.







# MORE PRODUCTS

## Beyond the Flame

Trust Urban to be able to complete your outdoor project to the highest standards, with our outdoor cooking facilities.

We can bespoke outdoor kitchens to your design, work with your designer, or create something special just for you.

We also know that many of you love to cook on wood, so we can offer a very specialised range of woodburning products for the most ardent chef. Professional versions, too!



BESPOKE OUTDOOR KITCHENS



OUTDOOR COOKING SYSTEMS



GAS BBQs & KITCHENS

# MIX & MATCH YOUR FUEL BED?

Beyond the Flame

We really like your style! So, of course, we offer the widest options for the fuel bed. Our Black Crystalight gas media is made from ceramic glass (below centre) and is the standard fuel bed with every gas fire. There are also White and Clear options.

Then, if you wish, you can add from our new range of High Definition ceramic pebbles.

With our Wall Fire outside fireplaces you can also add High Definition ceramic logs.





# CERAMIC PEBBLES

Our latest range of HIGH DEFINITION pebbles.  
More variation in shape and texture. It's your choice.



ALASKAN

PAGAN



DAZZLE



MOONROCK



SATURN



# SPECIFICATIONS

Gas burners are supplied with black Crystalight gas media and a steel weathercover.

## CONCRETE COLOURS



### ASTRA FIREBOWL

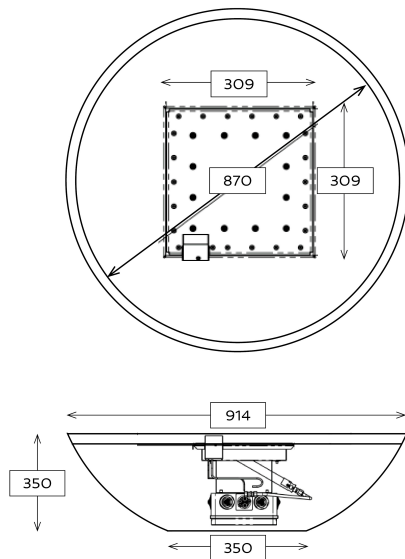

Gas input 15kW/hr (NG or LPG)  
Approximate weight 150 kg

### SQUARE FIREPITS

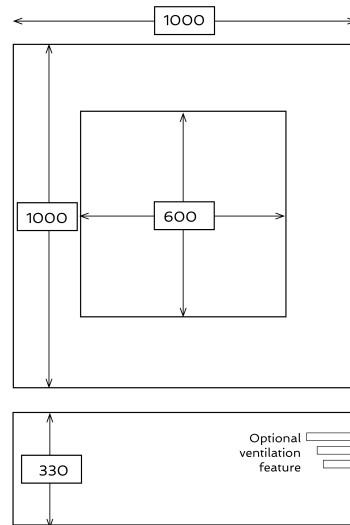

Gas input 15kW/hr (NG or LPG)  
Approximate weight 200 kg

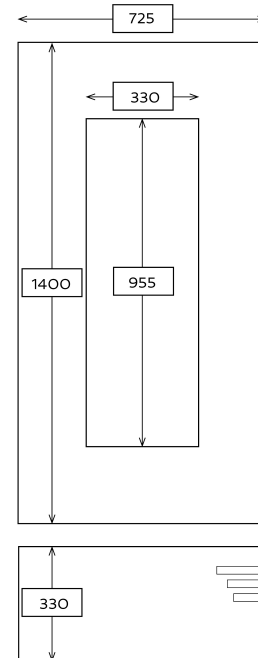

Gas input 15kW/hr (NG or LPG)  
Approximate weight 200 kg

### RECTANGULAR FIREPITS

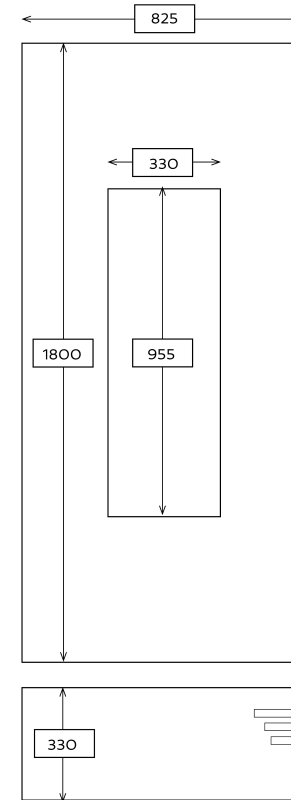

Gas input 15kW/hr (NG or LPG)  
Approximate weight 225 kg

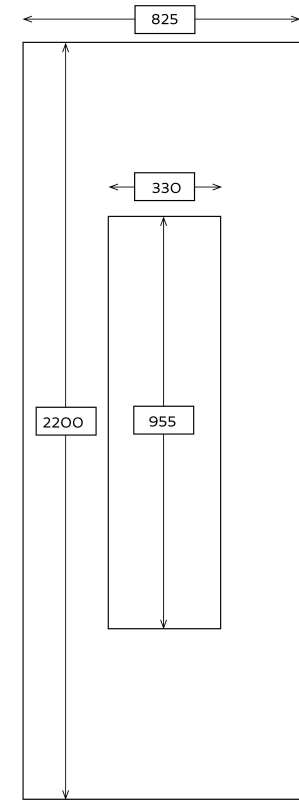

Gas input 15kW/hr (NG or LPG)  
Approximate weight 250 kg

Every one of our handmade concrete firepits will be unique and each may be permeated by a rich complexity of colour or shade variation. No single sample or image can tell the whole story. Our six colours offer a balanced range in a contemporary design - rich and natural - but every firepit will be different to a certain extent. Have a lovely surprise when yours arrives! There is no warranty on concrete products, except for the gas fire components of course. See [warranty here](#).





# URBAN OUTDOORS

27 Old Gloucester Street, London, WC1N 3AX

+44 (0)207 183 1806  
[www.urban-outdoors.co.uk](http://www.urban-outdoors.co.uk)

All dimensions are approximate.  
Product specifications may change without notice.  
All transactions are made subject to our published terms & conditions. Thanks to Silverland Stone for the loan of porcelain tiles.

© Copyright Urban Outdoor Living LLP 2019